

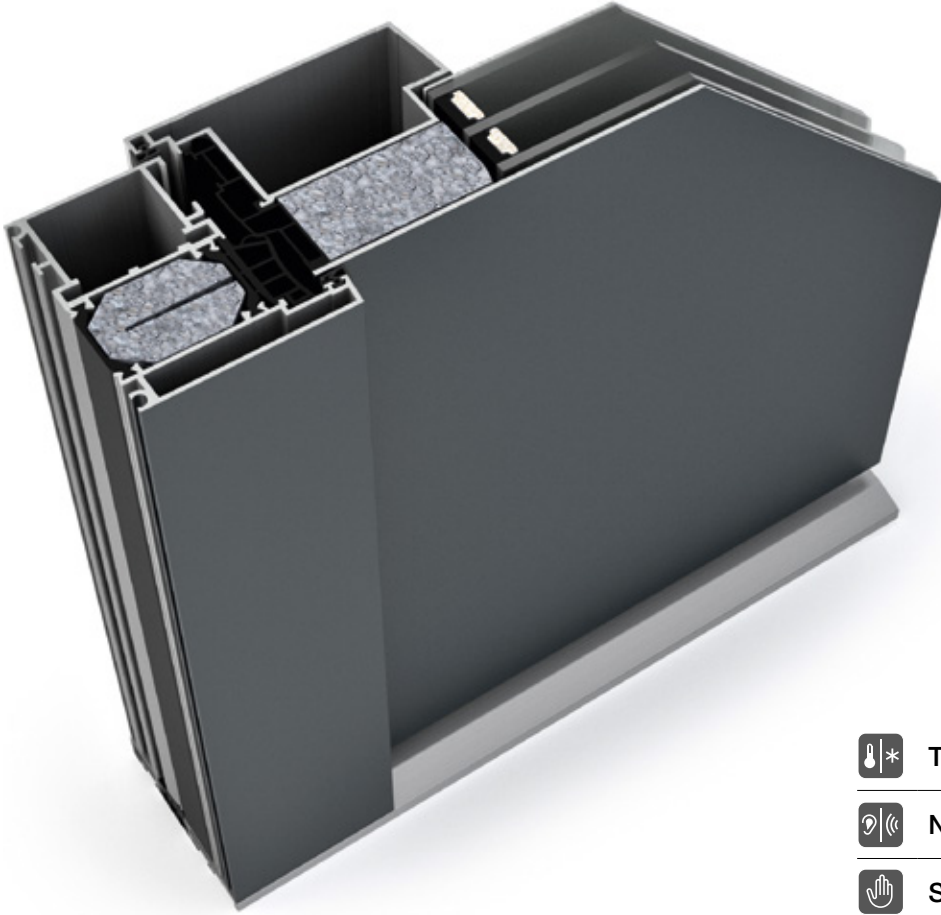





AT 510 ALUMINIUM ENTRANCE DOOR



	Thermal insulation	U_D as low as 0.95 W/(m ² K)
	Noise reduction	up to 38 dB
	Security	up to RC2
	Locking	Multi-point locking
	Construction depth	93 mm

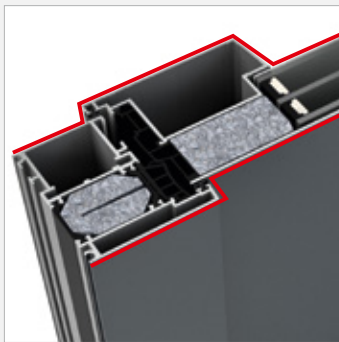

Round edge on inside,
square edge on outside



Panel structure with insulating
glass core for thermal stability

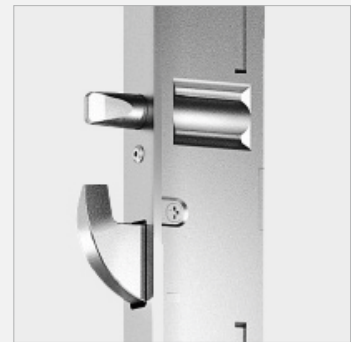

5-lever locking as standard for
highest security

AT 510

Diagram

Section - bottom

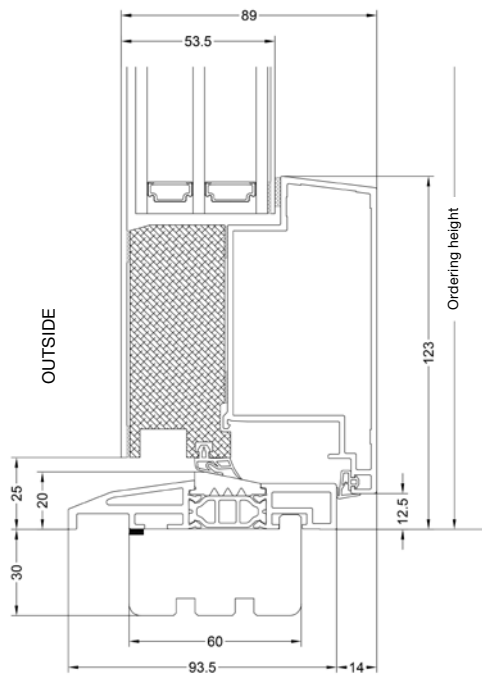

Side section - top

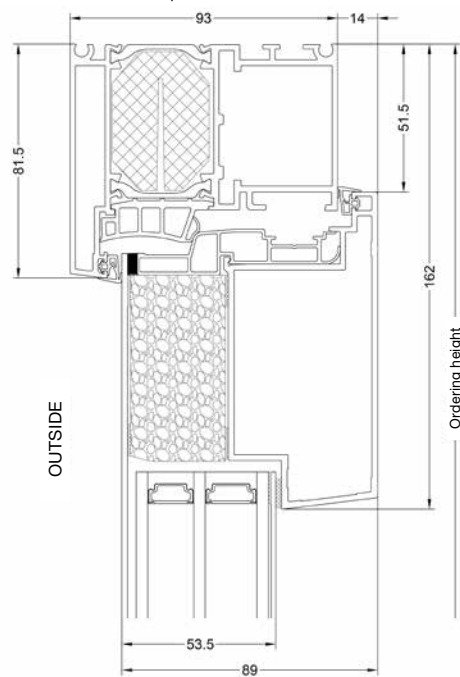

PG



PM



GD



GA

Further entrance door options can be found in the Door Designer:



Internorm Fenster GmbH

A-4050 Traun
 Ganglgutstraße 131
 T +43 (7229) 770-0
 office@internorm.com

Internorm Windows UK Ltd

Unit D, Colindale Business Park
 2-10 Carlisle Road, NW9 0HN, London
 Tel.: +44 (0) 208 205 9991
 Email: office@internorm.co.uk